

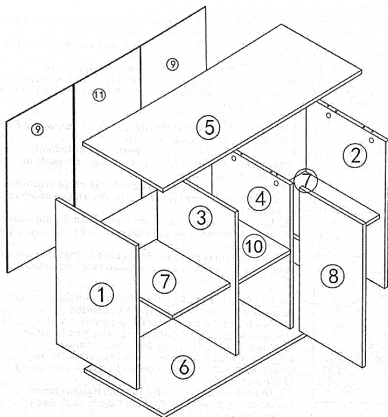













READ AND SAVE THIS INSTRUCTIONS FOR FUTURE USE



ASSEMBLY & INSTRUCTION MANUAL



	A x16		F x28		K x32
		M4*12			
	B x16		G x 2		L x 4
	C x24		H x 2		M x 8
				M4 * 35	
	D x 1		N x 2		
	E x 2		V x 6		

